

“Better than Bessel” Linear Phase Filters for Data Communications

Richard Markell

INTRODUCTION

The pace of the world of digital communications is increasing at a tremendous rate. Daily, the engineer is requested to compact more data in the same channel bandwidth with closer channel spacing. As an example, multilevel Pulse Amplitude Modulation (PAM) systems can be used to compress data into a bandwidth limited channel. The most typical PAM system is simply ones and zeros, the binary system. By shifting from a two-level system to a four-level system, we double the data bandwidth in a bandwidth limited channel at the expense of requiring a 8dB higher signal-to-noise ratio at the receiver.¹ This signal-to-noise trade-off to cram more bits into the same bandwidth is why filtering is becoming more and more critical in data transmission. This is precisely why the LTC data communications filters were born.

Filters such as the Bessel switched capacitor filter (LTC1064-3), although having excellent transient response, have very poor noise or adjacent channel rejection. DSP is a help if the designer is trying to use telephone bandwidth, but is not fast enough for efficient uses of 100kHz of bandwidth, let alone 200kHz, where data rates approach 400 to 800kbps.

Enter the LTC1264-7 Linear Phase Filter

The LTC1264-7 has group delay which is equal to the Bessel in the passband while it has rejection at the second harmonic of the cutoff frequency of -30dB versus the Bessel's -12dB. Thus, Bessel is banished, replaced by a better linear phase solution for the data transmission problem. Even the most conservative data compaction engineer will agree that the LTC1264-7 is “Better than Bessel.” Enough hoopla², let's get into the details.

Linear Technology's LTC1X64-7 family of filters incorporates 2 poles of phase compensation (allpass filtering) and 6 poles of lowpass elliptic filtering in a single 14-pin package. No external resistors are required. The LTC1264-7 is the first member of the Dash 7 linear phase filter family. The group includes the LTC1264-7, the LTC1164-7, the low power (4mA) member of the family with cutoff frequency to 20kHz and the LTC1064-7, the originator of the family, which provides cutoff frequencies to 100kHz.

This application note discusses some of the requirements and techniques for using filters in digital communications. The terms “channel bandwidth,” “eye diagrams” and “linear phase” filtering are discussed without the need for the “engineering speak” which permeates many textbook explanations of the same subjects.

The eye diagram measures the “quality” of the transmission channel. The eye opening provides subjective indication of bit error rate or the “goodness of the channel.” This will be discussed in more detail later in this text.

¹ Kamilo Feher, “Digital Communications: Microwave Applications,” Prentice-Hall Inc., Englewood Cliffs, NJ, 1981.

² Hoopla is an utterance designed to bewilder.

Application Note 56

The eye diagram shown in Figure 1 is illustrative of 100kHz phase performance. Notice the lack of over or undershoot at the transitions. The well-behaved nature of the transitions allows data coding to multiple levels while retaining the required signal-to-noise ratio (SNR). However, the real advantage of the LTC1264-7 is in the stopband rejection. Figure 2 shows an amplitude comparison of the responses of the LTC1264-7, the 8-pole Butterworth, the LTC1064-2, and the 8-pole Bessel filter, the LTC1064-3. The difference is dramatic! The LTC1264-7 attains 28dB attenuation at 2 times cutoff, while the LTC1064-3 attains only 12dB. The phase response of both filters remains linear through their passbands, although the LTC1064-3 extends this response to almost 2 times cutoff. Figures 3a, 3b and 3c, and Figures 4a, 4b, 4c and 4d detail the burst response and the transient response of the LTC1064-1, the LTC1064-2 and

the LTC1064-7 as an additional comparison criterion. We shall explore the effect all this has on digital transmission later in this article, but to effect this comparison a short explanation of some principles of digital transmission is first needed.

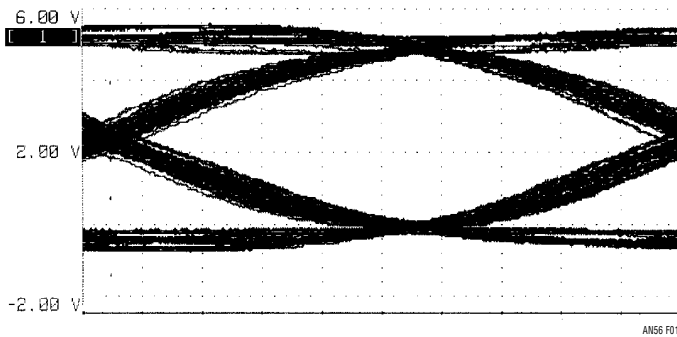

Figure 1. Eye Diagram LTC1264-7, $f_{CUTOFF} = 100\text{kHz}$, Data Rate = 200kbps

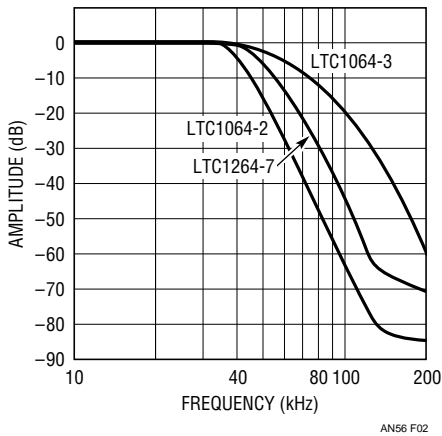

Figure 2. Filter Roll-Off Comparison, $f_{CUTOFF} = 40\text{kHz}$, for Butterworth 8th Order LPF, LTC1064-2, Bessel 8th Order LPF, LTC1064-3 and LTC1264-7 Linear Phase Filter

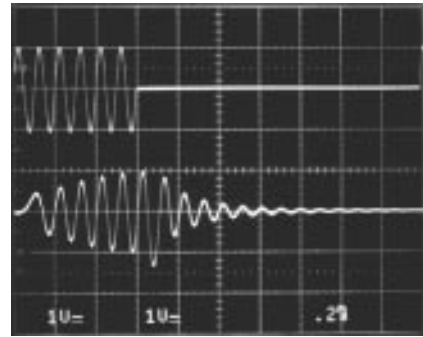

Figure 3a. Burst Response LTC1064-1, $f_{CLK} = 1\text{MHz}$, $f_c = 10\text{kHz}$, Burst: 10kHz Sine Wave

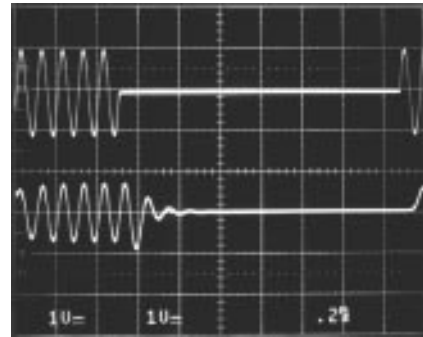

Figure 3b. Burst Response LTC1064-2, $f_{CLK} = 1\text{MHz}$, $f_c = 10\text{kHz}$, Burst: 10kHz Sine Wave

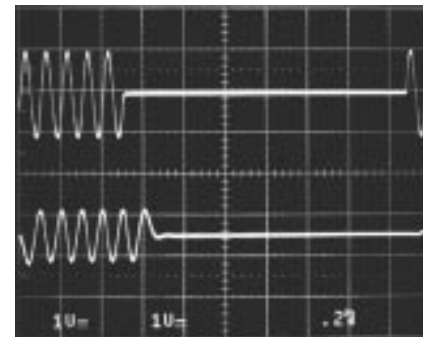

Figure 3c. Burst Response LTC1064-7, $f_{CLK} = 750\text{kHz}$, $f_c = 10\text{kHz}$, Burst: 10kHz Sine Wave

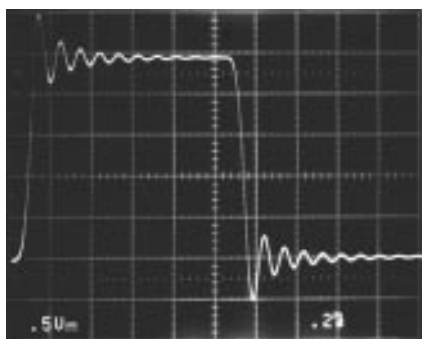

Figure 4a. Transient Response LTC1064-1,
 $f_{CLK} = 1\text{MHz}$, $f_C = 10\text{kHz}$, $f_{IN} = 480\text{Hz}$

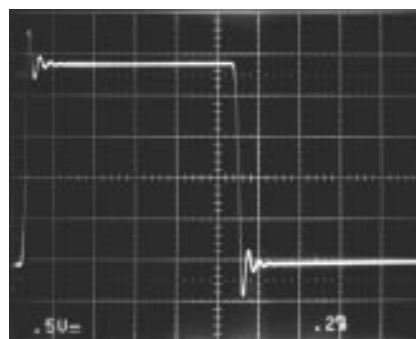

Figure 4b. Transient Response LTC1064-2,
 $f_{CLK} = 1\text{MHz}$, $f_C = 10\text{kHz}$, $f_{IN} = 480\text{Hz}$

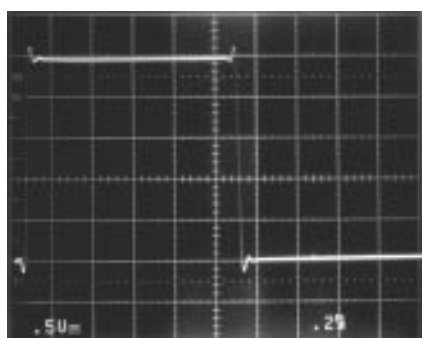

Figure 4c. Transient Response LTC1064-7,
 $f_{CLK} = 1\text{MHz}$, $f_C = 10\text{kHz}$, $f_{IN} = 480\text{Hz}$

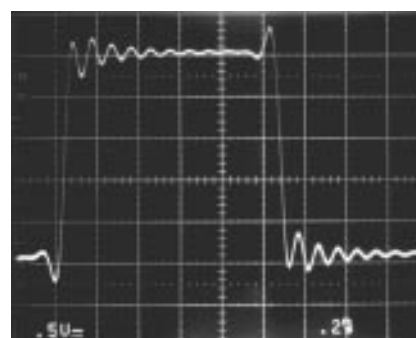

Figure 4d. Transient Response Equalized LTC1064-1, (See Appendix B),
 $f_{CLK} = 1\text{MHz}$, $f_C = 10\text{kHz}$, $f_{IN} = 480\text{Hz}$

SOME PRINCIPLES OF DATA TRANSMISSION

Transmission of data in a given bandwidth channel is more efficient when as many bits/second can be transmitted through this channel as possible. Shannon theorems show that the theoretical data rate limit is transmission of f_S symbols in a bandwidth ($BW = B$) of only $f_S/2\text{Hz}$. So, for a binary transmission where one symbol contains one bit, f_B , the number of bits per second is equal to the symbol rate, f_S . Figure 5 shows this situation schematically. For “M ary”³ systems, such as 4-level Pulse Amplitude Modulation (PAM), each transmitted symbol contains n information bits, where $n = \log_2 M$. In this case the symbol rate is $f_S = f_B/n$.

Consider the example where it is required to transmit a 100kbps source ($= f_B$). Theoretically this could be accomplished with a channel bandwidth, $B = f_S/2 = f_B/2 = 50\text{kHz}$.

With the aforementioned 4-level PAM scheme, the channel bandwidth reduces to $25\text{kHz} = f_S/2 = f_B/4$. This type of encoding is used by many types of digital communications systems. The trade-offs involve bandwidth versus encoding complexity. If the above mentioned 100kbps source **must** be passed in a bandwidth of $6.25\text{kHz} = f_S/2 = f_B/16$, it follows that 256-level PAM or an equivalently dense packing scheme must be used. Multilevel and multiphase signals require the filter be linear phase (to preserve pulse integrity in the time domain) while providing as much roll-off in the stopband as possible. More discussion of these topics is included in the discussion of “eye diagrams.”⁴

³ An M ary system contains M voltage levels. A binary system has 2 levels, whereas an M = 8 system has 8 levels and so on. A 2-level system can detect only 1 and 0, but higher level systems of PAM threshold in more than one place so as to transmit more information in a given bandwidth.

⁴ Also see the much more detailed discussions in: Feher, Dr. Kamilo, “Digital Communications--Satellite/Earth Station Engineering,” Prentice-Hall Inc., Englewood Cliffs, NJ, 1983.

Application Note 56

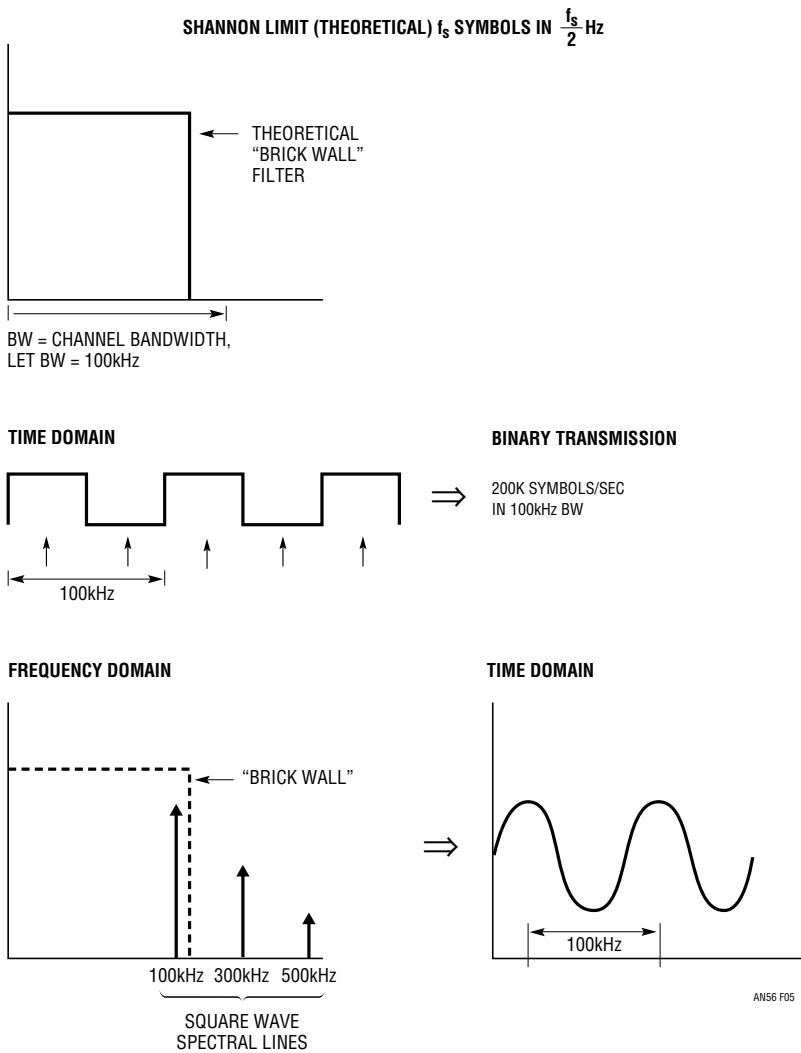

Figure 5. Shannon Data Transmission Shown Schematically

The channel with bandwidth $f_s/2$ Hz is the famous “brick wall”⁵ filter. This is the channel all filter designers strive for but no one can build. So we all strive to come as close as possible. If the ideal brick wall filter could be achieved, it would be as shown in Figure 6. Also shown in Figure 6 are two filters which are possible to realize with 8th order switched capacitor filter technology and external resistors. Both filters have theoretically infinite attenuation at 1.5 times the cutoff frequency. The filter with the peaked response can be corrected by a multiplication factor $(\chi/\sin \chi)$ so that when the signal is digitally sampled (a procedure common to digital transmission of signals), the result is optimally flat in transmission bandwidth.

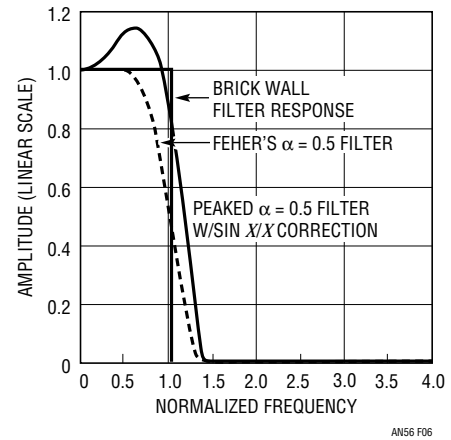

Figure 6. Brick Wall Theoretical Filter and Two Filters Realizable with 8th Order SCF Technology
Note: Linear Amplitude Scale

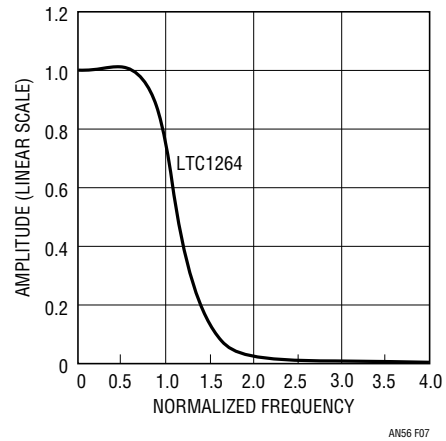

Figure 7. Amplitude Response LTC1264-7
Note: Linear Amplitude Scale

Figure 7 shows the amplitude response, normalized, for the LTC Dash 7 series of filters. A comparison with Feher’s⁶ alpha = 0.5 filter (where alpha is the roll-off factor: alpha = 0 is the brick wall filter, alpha = 1 implies twice the theoretical bandwidth requirement) shows few differences in the amplitude response. The LTC1264-7 will operate to 250kHz, while the LTC1164-7 will operate (using only 4mA of supply current) to 20kHz. The LTC1064-7 will operate to 100kHz. **Best of all, the eye patterns for these filters are superior!! To understand why, read on!**

⁵ A brick wall filter has a frequency response which is flat (or 0dB) with no ripple in the passband to the cutoff frequency, f_c , then rolls off to infinite attenuation at the beginning of the stopband, f_s . The brick wall filter is only theoretical, thus $f_c = f_s$.

⁶ Feher, *ibid.*

Why Linear Phase?

An additional criterion that the “close to ideal” data transmission filter must strive to achieve (and they didn’t tell you in college) is a linear phase response.

Linear phase means that each frequency which passes through the filtered channel will be delayed in time linearly according to its frequency. Higher frequencies have smaller (in magnitude) delays. The specification of group delay plots this phenomenon, “the delay of the group (of frequencies),” versus frequency. The objective of a group delay plot is to have a flat line representing the situation where all frequencies are delayed the same amount. This is the best case linear phase filter. All other compromises are based on this ideal situation.

Group delay is a most important characteristic in digital data transmission applications because a filter with flat group delay passes a square wave with little distortion. The LTC “Better than Bessel” filters compromise phase linearity outside the passband to achieve more amplitude attenuation in the stopband. Feher, a recognized authority in the field of digital communications, notes that for data transmission, filters should be linear in phase to their –10dB amplitude points in the filter’s transition region. The LTC “-7” filters meet this criterion (Figure 8).

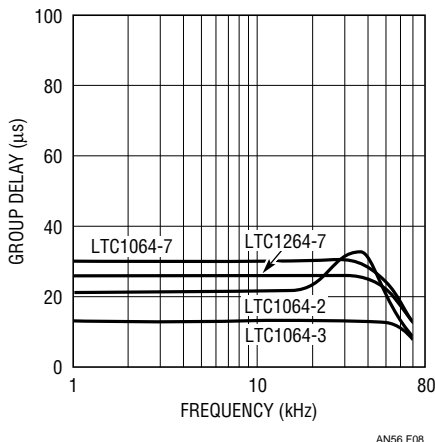

Figure 8. Group Delay vs Frequency for Four Filters: LTC1064-2/LTC1064-3/LTC1064-7/LTC1264-7, f_c (All Filters) = 40kHz, $V_S = \pm 7.5V$

FILTERS FOR DATA COMMUNICATIONS: HOW AND WHY TO SELECT THEM

The perfect filter for data communications, if it could be implemented, would be Feher’s “brick wall,” linear phase, flat group delay, alpha = 0 filter as shown in Figure 9. But, we cannot build this type of filter.

In this section, we describe the LTC1064/LTC1164/LTC1264-7 “Better than Bessel” filter family. These are 6th order lowpass filters with a 2nd order allpass (phase equalizing) section designed for data communications. These filters are contained in a single 14-pin DIP or 16-pin SOL package. They are a complete integrated solution with the resistors required to program the response of the switched capacitor filter sections integrated onto the die of the filter.

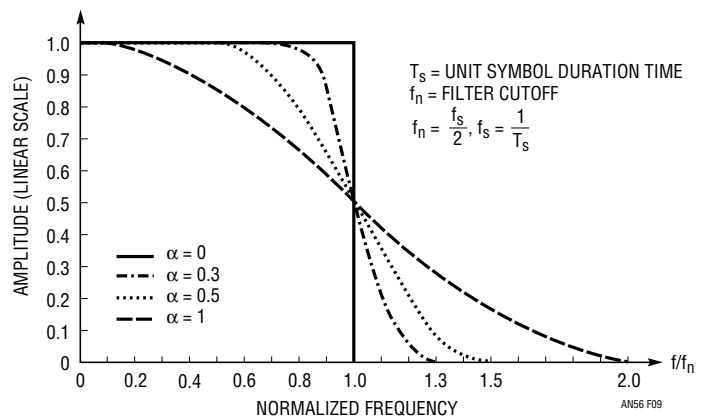

Figure 9. Amplitude Characteristics of the Nyquist Channel for Impulse

LTC1064/LTC1164/LTC1264-7 Filters

The Dash 7 filters were designed by making them “Better than Bessel.” That is, the low Q Bessel response was modified to incorporate a notch or zero in the stopband to “pull down” the amplitude response just outside the passband of the filter. This increases the attenuation from the Bessel’s –12dB at 2× cutoff to –28dB for the LTC1264-7 (also at 2× cutoff). This is shown in Figure 10. The LTC1064-7 and LTC1164-7 have even better stopband performance at –34dB at 2× cutoff. While this increased

Application Note 56

attenuation has little effect on the eye diagram, it increases the attenuation of the carrier signal while not degrading the data that is superimposed on this carrier. This means better (that is lower) bit error rates for the same bandwidth channel.

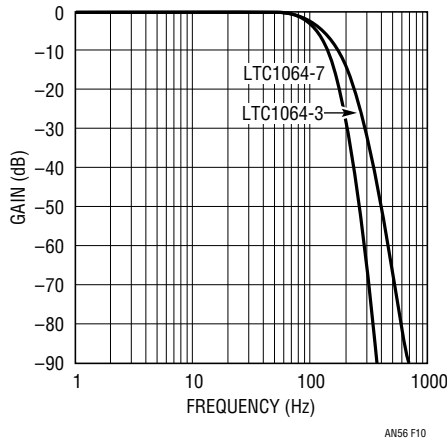

Figure 10. Amplitude Response: LTC1064-3 vs LTC1064-7 (Bessel vs “Better than Bessel”), $f_c = 100\text{Hz}$

MEASUREMENT: THE EYE DIAGRAM, AMPLITUDE AND GROUP DELAY

Since the perfect lowpassed transmission channel does not exist, a means must be found to evaluate channel quality. This means is the so-called “eye” diagram. The eye diagram is generated by the setup shown in Figure 11. Figure 12 shows the pseudorandom code generator circuitry used as the random data source.

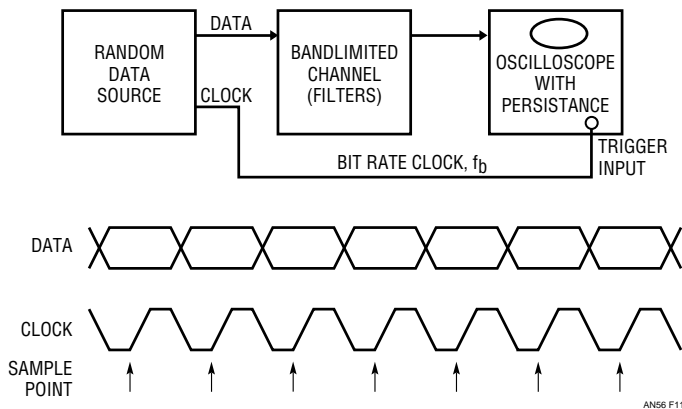

Figure 11. Eye Diagram Generation Circuitry and Data Timing

Symbols transmitted through a theoretical Nyquist channel should have no degradation in amplitude response, and as such, the measured eye diagram opening (of a real channel) shows graphically the “quality” of the transmission channel (which includes the lowpass filter inserted in the transmission path). It can be shown that the degradation in the eye opening is directly related to intersymbol interference (the interference in the detection of one symbol in the presence of another) and therefore is a measure of the systems bit error rate (see Feher)¹.

With this background, some eye opening diagrams exemplify how the LTC1264-7 filter is optimized for applications in data communications. Figures 13 and 14 show the eye diagrams of the LTC1064-2 (8th order Butterworth LPF) and the new LTC1264-7 linear phase filter (6th order elliptic LPF + 2nd order phase correction network). It can be seen that if a digital system thresholds at the midpoint in the eye diagrams, the Bit Error Rate (BER) will be higher for the eye diagram with the smaller “eye opening.” The calculation of Intersymbol Interference (ISI) degradation due to “channel” or filter imperfections is a measure of degradation in BER and is calculated:

$$\text{ISI degradation} = 20 \log (\text{actual eye opening}/100\% \text{ eye opening})$$

Thus, it can be seen that the LTC1264-7 is a far superior filter when used to maximize channel efficiency in digital systems. However, we must look at the LTC1064-3 (8th order Bessel LPF) for comparison.

The LTC1064-3 is shown in the eye diagram illustrated as Figure 15. This eye diagram shows ISI degradation similar to the LTC1264-7 with better jitter specifications. Although the Bessel filter appears to be superior from the viewpoint of the eye diagram, the reader should remember that the LTC1264-7 has far superior stopband attenuation, meaning better attenuation of the “carrier” at 27.5kHz in this example. This translates to better bit error rates. The system user must trade off ISI degradation, jitter and the filter attenuation to ensure best “channel performance.” In addition, remember that the eye diagrams shown here are for 2-level systems (0V and 5V). For M-level systems, the increased spectrum efficiency means greater signal-to-noise ratios are required necessitating the roll-off characteristics of filters like the LTC1264-7.

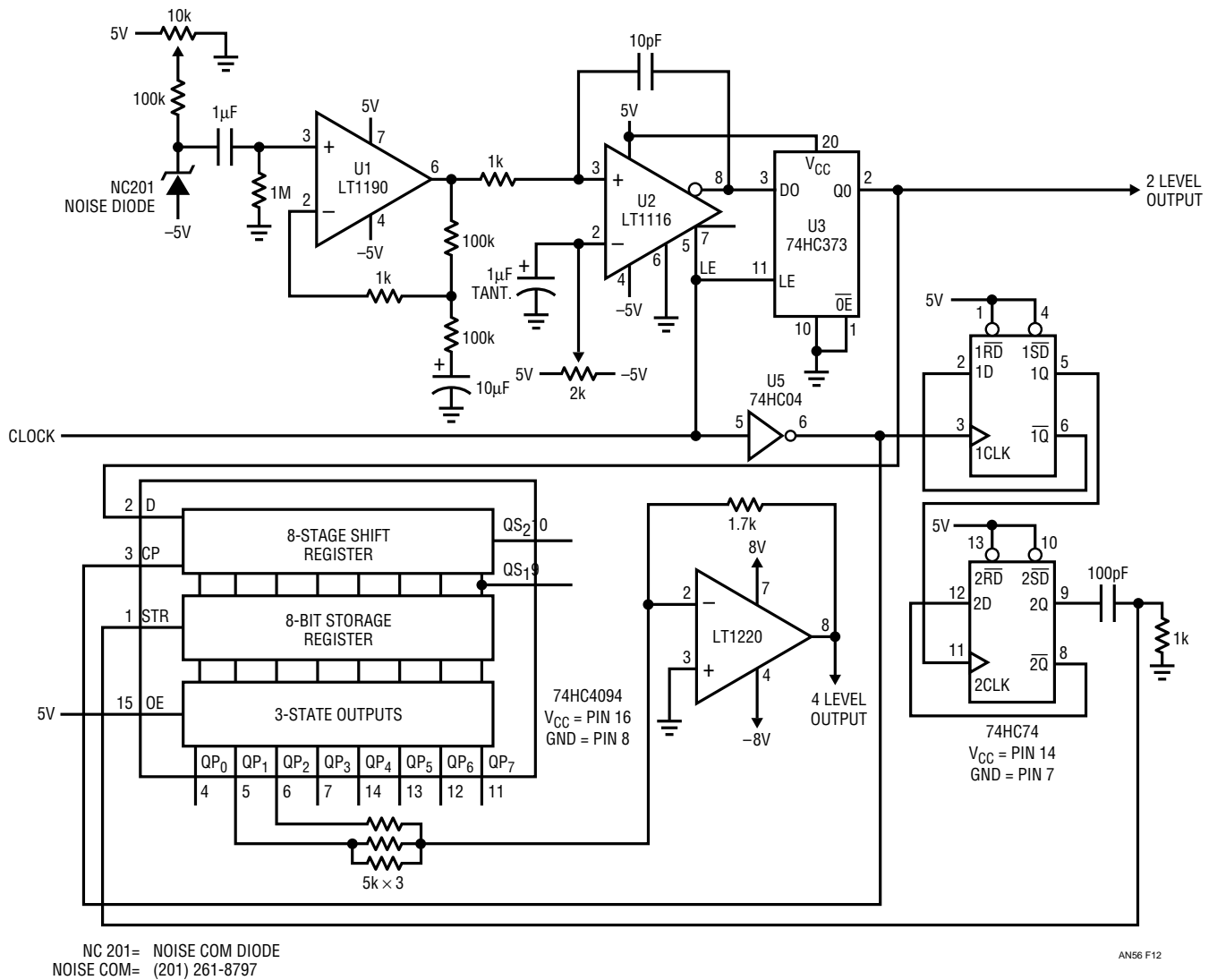

Figure 12. Pseudorandom Code Generator Schematic Diagram

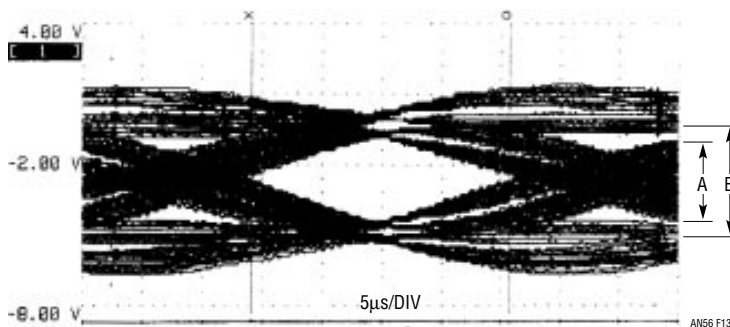

Figure 13. LTC1064-2: $f_{CUTOFF} = 13.7\text{kHz}$, $f_S = 27.5\text{kbps}$,
ISI Degradation = $20 \text{Log}(0.75) = -2.5\text{dB}$, A = 75% Opening,
B = 100% Opening

Application Note 56

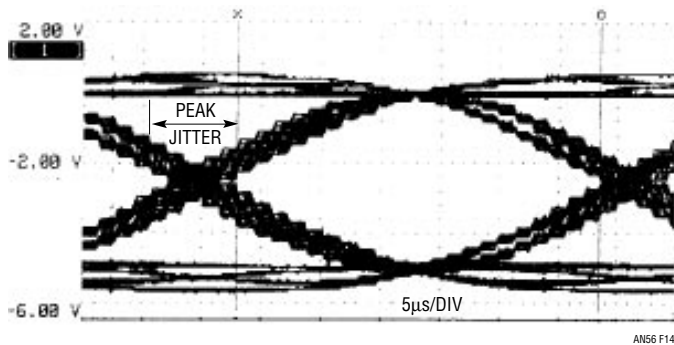

Figure 14. LTC1264-7: $f_{CUTOFF} = 13.7\text{kHz}$, $f_S = 27.5\text{kbps}$, ISI Degradation = -0.46dB , Peak Jitter $\approx 5.6\mu\text{s}$

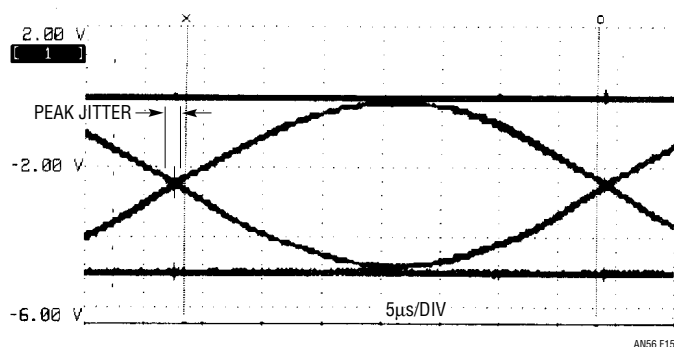

Figure 15. LTC1064-3: $f_{CUTOFF} = 13.7\text{kHz}$, $f_S = 27.5\text{kbps}$, ISI Degradation = -0.94dB , Peak Jitter $\approx 1.2\mu\text{s}$

To conclude, the LTC1264-7 is a linear phase, better than Bessel, switched capacitor filter optimized for the data communications world. The filter will operate to a cutoff frequency of 200kHz while providing linear phase through its passband. The filter can be used in satellite communications, cellular phones, microwave links, ISDN networks and many other types of digital systems.

References:

1. Kamilo Feher, "Digital Communications: Microwave Applications," Prentice-Hall, Inc., Englewood Cliffs, NJ, 1981
2. Dr. Kamilo Feher and Engineers of Hewlett-Packard Ltd., "Telecommunications, Measurements, Analysis and Instrumentation," Prentice-Hall, Inc., Englewood Cliffs, NJ, 1987
3. Dr. Kamilo Feher, "Digital Communications: Satellite/Earth Station Engineering," Prentice-Hall, Inc., Englewood Cliffs, NJ, 1981

APPENDIX A

Seven Months and No Cigar: The LTC1264-7 Germination Saga

John Massey
Electronic Innovators, Inc.
11902 Parkland Ct., Fairfax, Virginia 22033

The transmission quality of any phase modulated signal depends on the group delay in the passband and the attenuation in the stopband of the (filtered) transmission channel. In synchronous detection the receiver IF center frequency is zero and the IF amplifier becomes a lowpass filter. Since the RF filter operates at a much higher frequency than the IF, it needs all the group delay margin that the total receiver design can give it. The lowpass IF amplifier wants to have a Bessel response characteristic since the Bessel response has the best group delay of any of the classical filters. Unfortunately the Bessel filter has very poor rejection characteristics in the stopband. In a

very noisy environment one would prefer to have Butterworth or elliptical roll-off characteristics and Bessel group delay.

About three years ago I set out to design such a filter. It was to have Butterworth roll-off and Bessel group delay. I knew that although I really wanted elliptical characteristics the Butterworth characteristics would be easier to phase equalize (compensate). After returning a number of computer programs which were supposed to optimize group delay characteristics (and didn't), I found one that did. The computer generated filter design looked great on paper

although it contained 29 operational amplifiers. A simple Monte Carlo analysis showed that part tolerances would be a problem. I first built the most complex section and put it on the analyzer. Unfortunately the operational amplifier could not read and thus it did what it knew to do which was to have characteristics which were unlike the simulation. After some looking I found an operational amplifier which would track the simulation very closely if I adjusted the resistors somewhat. Now I not only had 29 operational amplifiers but 30 adjustments. The adjustment was very difficult. Each section of the filter had to be adjusted individually; after that they all had to work together. I wrote some special software which ran on the IEEE bus to compare the actual filter data from the analyzer with the simulation data. The computer would then display the difference between the two in gain and group delay. Adjustment took two days and I got to about twice the differential in group delay that I set as my goal. The circuit had about two times the ambient differential specification I desired when I spray canned the card. This process took about seven months and resulted in a prototype Vector card. I was devastated; seven months and not even close.

One day some time later, I was reading EDN and came across an article about switched capacitor filters by Rich Markell. I had talked to a number of such vendors asking if they knew what group delay was and were they interested in optimizing for group delay. Most said what is

group delay? The few who knew said all their filters would have the classical group delay of a nonswitched capacitor filter. Rich said he knew and asked why it was important to me. I poured out my “seven months and no cigar” story. He seemed really interested. A few days later he asked if I would be interested in looking at a switched capacitor filter breadboard which LTC would build. You bet!! The first sample was about where I was with my 29 operational amplifiers but was about two square inches in board space with external resistors. It was also about twice as stable as my design when spray canned. But Rich said that I should not be able to see the changes in group delay. I told him to get to a spectrum analyzer and look. Then a new design with external resistors values arrived in the mail. With this design I could bridge the exact resistor values and build the design. Adjustment of the filter took less time than setting up and calibrating the analyzer. I moved one resistor just a little. I then had Bessel performance in the passband and elliptical performance in the stopband. My dream was to have LTC put the resistors inside: NRE 12k to 15k. As dreams sometimes go, others were interested in my vision for those elliptical skirts and LTC decided to put the resistors inside. Thus, I go from 29 operational amplifiers, 30 adjustments and no cigar to a 14-lead package with no adjustments-- and a box of cigars. Want to adjust the skirt edge a little? Just move the clock. Is this magic or what?!

APPENDIX B

Filter Compromises

The LTC1064-7, LTC 1164-7 and LTC1264-7 are the only “Better than Bessel” filters on the market that include all resistors integrated onto the silicon. The obvious question that many designers will have is: Can I do better? Let’s explore this.

Let’s try to phase equalize the LTC1064-1 elliptic 8th order LP filter. This filter is a very selective filter and, as such, approximates a brick wall filter. Figure B1 shows the group delay response for the LTC1064-1 at a normalized frequency of 1Hz. Our objective is to flatten the group delay curve as much as possible.

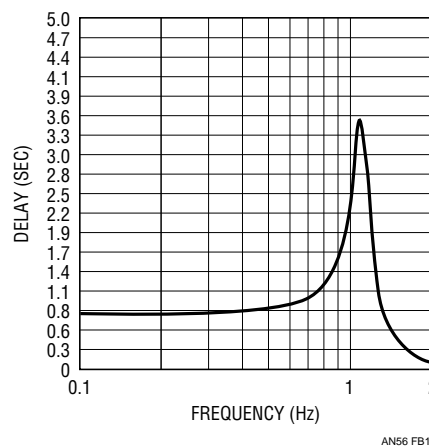

Figure B1. Group Delay Response LTC1064-1, $f_{\text{CUTOFF}} = 1\text{Hz}$

Application Note 56

Figure B2 shows the architecture used for building allpass filters. For more detailed information see Appendix D. Implementation of the allpass network can be partially done by FilterCAD as shown in Figure B3. Note carefully that to **implement** an allpass network, the f_0 , Q and f_n values are entered *only once* into the custom filter design table. See Appendix D if this issue is not clear.

By incorporating the 6th order allpass filter before the LTC1064-1, we have smoothed the variations in the group delay response. Figures B4 and B5 show the group delay response of the system for a 10kHz cutoff frequency. Figures B6 and B7 show the amplitude characteristics.

Note: Each allpass section is very sensitive to the requirement $R_6/R_5 = 1/2 H_{0BP}$.

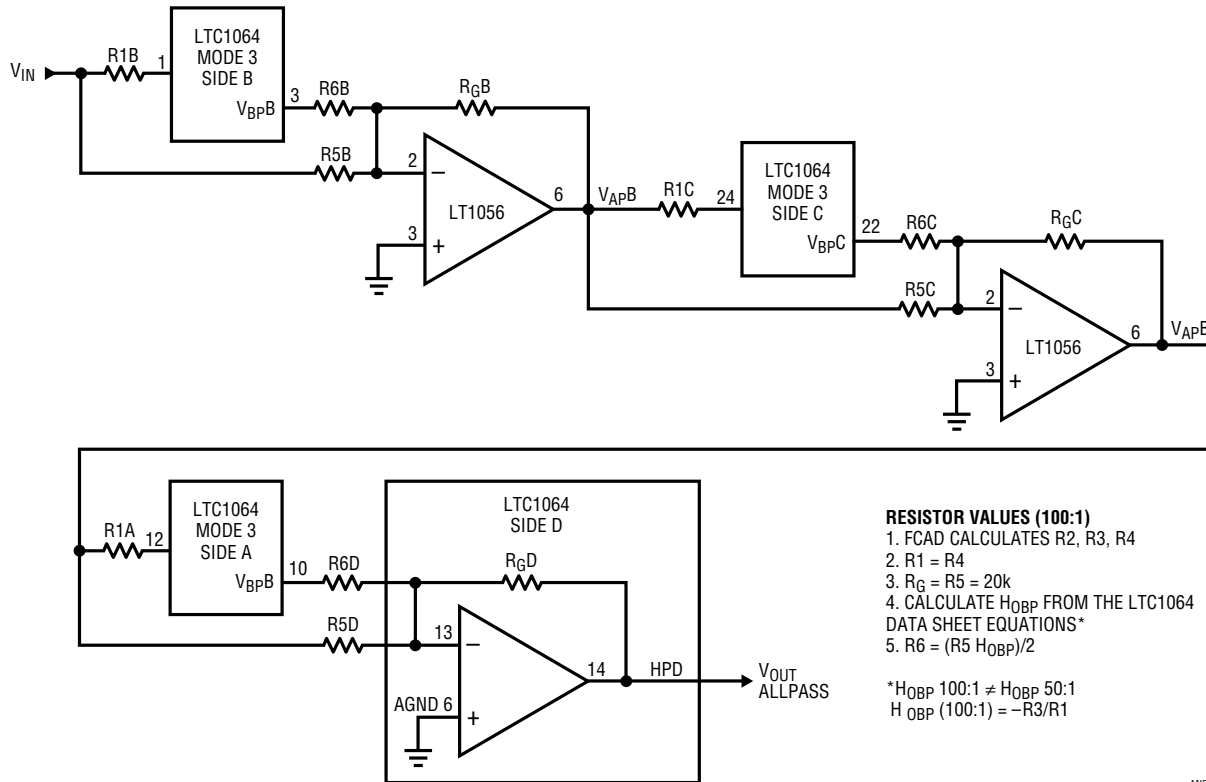

AN56 FB2

Figure B2. Allpass Network Configuration Using LTC1064

FilterCAD Ver 1.700
 FILTER DESCRIPTION: **ALLPASS 6TH ORDER FOR LTC1064-1**

FILTER TYPE: LOWPASS
 FILTER RESPONSE: CUSTOM

PASSBAND RIPPLE: 0.0000 dB
 ATTENUATION: 0.0000 dB
 ACTUAL ATTENUATION: 0.0000 dB
 FILTER GAIN: 0.0000 dB
 ORDER OF FILTER: 6
 CORNER/CENTER FREQ: 1.0000 Hz
 STOPBAND FREQUENCY: 1.0000 Hz

POLE/ZERO LOCATIONS FOR FILTER

STAGE	F _o	Q	F _n
1	1.0000	0.5470	INFINITE
2	0.7450	0.9430	INFINITE
3	0.5200	0.5470	INFINITE

OPTIMIZE STRATEGY: NOISE
 DEVICE: LTC1064
 CLOCK RATIO: 100:1
 CLOCK FREQUENCY: 100.0000 Hz

FILTER

STAGE	MODE
1	3
2	3
3	3

RESISTORS (ABSOLUTE VALUES)

STAGE	R1	R2	R3	R4	R5	R6	R _G	R _H	R _L
1		36.56K	20.00K	36.56K	USE GUIDELINES ON ALLPASS 6TH ORDER BLOCK DIAGRAM TO DETERMINE R1, R5, R6, R _G				
2		20.00K	25.31K	36.03K					
3		20.00K	21.03K	73.96K					

RESISTORS (1% VALUES)

STAGE	R1	R2	R3	R4	R5	R6	R _G	R _H	R _L
1	36.50K	36.50K	20.00K	36.50K	20.00K	5.40K	20.00K		
2	35.70K	20.00K	25.50K	35.70K	20.00K	7.10K	20.00K		
3	73.20K	20.00K	21.00K	73.20K	20.00K	2.87K	20.00K		

STAGE	H _{OBP} /2	R6/R5	
1	0.274	0.270	
2	0.357	0.355	R6/R5 = 1/2 H _{OBP}
3	0.143	0.144	H _{OBP} (100:1) = -R3/R1

AN56 FB3

Figure B3. FilterCAD Implementation Screen Used to Calculate Resistors R2, R3 and R4. R1, R5, R6 and R_G Must Be Calculated According to Figure B2's Instructions

Application Note 56

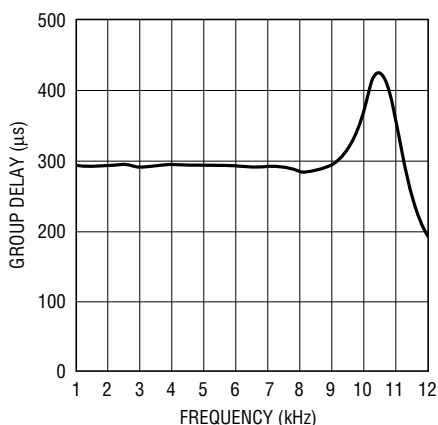

AN56 FB4

Figure B4. LTC1064 6th Order Allpass Plus LTC1064-1 Group Delay vs Frequency

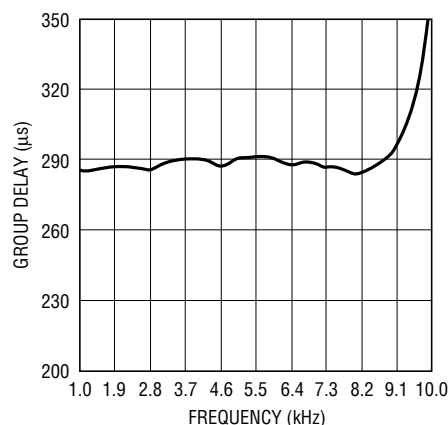

AN56 FB5

Figure B5. LTC1064 6th Order Allpass Plus LTC1064-1 Detailed Group Delay in Filter Passband

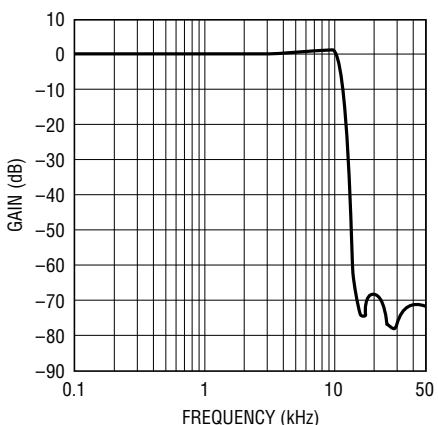

AN56 FB6

Figure B6. Amplitude Response LTC1064 6th Order Allpass Network Plus LTC1064-1 Elliptic Filter

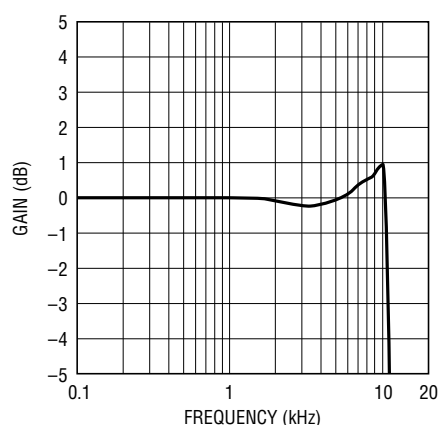

AN56 FB7

Figure B7. Detailed Amplitude Response LTC1064 6th Order Allpass Network Plus LTC1064-1 Elliptic Filter

APPENDIX C

The LTC1264-7 Filter vs DSP

The LTC1264-7 is the only linear phase “Better than Bessel” filter available in an SO package. Its 250kHz maximum cutoff frequency far exceeds the cutoff frequencies that can be realized with Digital Signal Processing (DSP). A similar DSP Finite Impulse Response (FIR) filter at only 30kHz cutoff frequencies would require approximately 100 filter taps (coefficients) using a multiplier with at least 12-bit precision. Realization of this filter would necessitate 45ns multiplication cycles translating to at least a 22MHz clock frequency. A 250kHz filter would

require 5.4ns multiplication cycles and at least a 183MHz clock. These speeds are years, if not a decade, away from realization in silicon.

What about DSP?

The current craze about DSP, while perfectly warranted in many cases, cannot hold a candle to the good old analog switched capacitor approach at frequencies much above 20kHz to 30kHz. Let’s see why.

DSP Fundamentals

DSP operates by first digitizing the data via an analog-to-digital converter. Next, the digitized data is digitally filtered by multiplying each digital sample by a “coefficient.” Many samples must be multiplied by a coefficient and then “accumulated” in an accumulation register to perform the desired filtering function. The number of coefficients rarely is less than 20 and can sometimes approach 200 in a complex filter.

DSP has advantages and disadvantages like any other technology. DSP filters do not drift over time like op amp RC filters can. They are quite good in approximating the desired filter response characteristics required. Additionally, when the so-called FIR filter is designed, it has linear phase by definition.

DSP is not free, however. Quantization errors in the ADC limit accuracy of the DSP algorithms. Sixteen-bit ADCs, while readily available, generally do not achieve 16-bit accuracy and noise performance even with the best circuit board layout. Quantization errors also creep into the filter coefficients limiting filter performance. Overflow errors in the arithmetic registers can occur without careful software design and have been known to crash the system. Finally, aliasing is a problem with DSP since it is a sampled data system.

DSP and Data Communications

A direct comparison between the switched capacitor approach using the LTC1264-7 and the DSP approach is

useful to see how the two approaches compare. Figure C1 shows in block diagram format a DSP filter implemented with discrete registers, multipliers, FIFOs and additional digital circuitry. (The illuminated may exclaim at this point: but what about the TMS320 or the 56001? The illuminated will see why this approach is far too slow.) The circuitry to be of any use at all for speeds useful to data communications must use very fast parts.

Figure C2 shows a DSP filter response calculated using a DSP design program. It is an FIR design and therefore has linear phase. This filter requires a sample rate of 100kHz. As shown, it has a 30kHz cutoff frequency using 12 bits of precision. The DSP program calculates that the filter requires 100 coefficient taps.

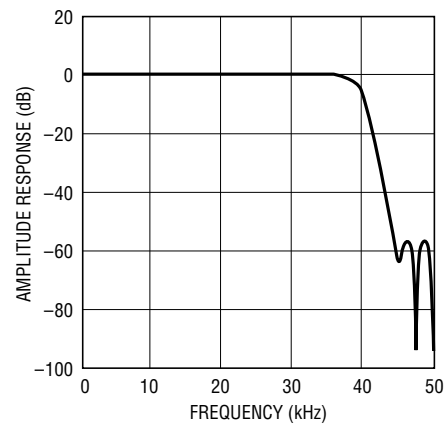

AN56 FC2

Figure C2. FIR Filter, Kaiser Window, 100kps, $f_{CUTOFF} = 30\text{kHz}$, 12-Bit Precision, 100 Taps

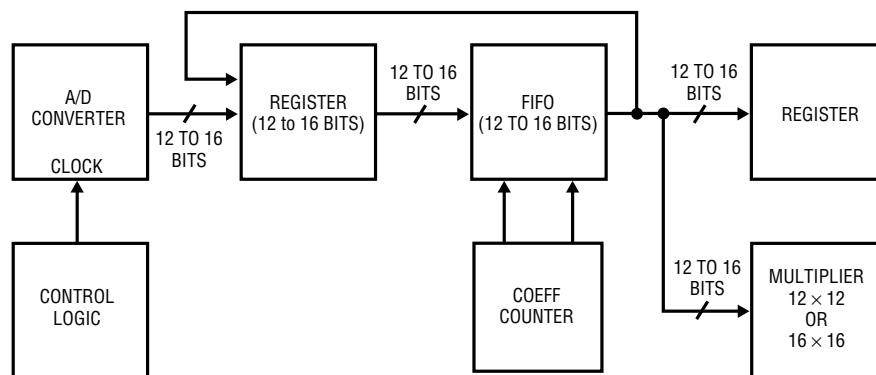

AN56 FC1

Figure C1. Simplified DSP Filtering Block Diagram

Application Note 56

This 30kHz FIR filter would require a 12-bit parallel A/D at its front end. The A/D must convert in less than 45ns. Using a 45ns multiplier/accumulator cycle time, we can calculate:

$$45\text{ns} \times 2 \text{ cycles (multiply, then accumulate)} \times 100 \text{ taps} \\ = 9\mu\text{s} + 1\mu\text{s overhead} = 10\mu\text{s}$$

Thus, we need 45ns multipliers to achieve our 30kHz filter which requires a 100kHz sample rate. These multipliers are 1994 state-of-the-art components. They require excellent skills to apply and they are expensive.

The LTC1264-7 Solution Wins

As the above example shows, DSP cannot yet go fast enough to do many of the fundamental filtering requirements for data communications. The 30kHz filter designed in the previous section with DSP can be much more easily implemented by a single switched capacitor filter. The LTC1064-7 linear phase lowpass filter can easily handle the 30kHz requirement. Should the user want to take advantage of the LTC1264-7's 250kHz maximum cutoff frequency, a comparable DSP solution would require blazing fast 5ns multipliers and similarly fast registers and peripheral logic. These type of devices do not exist (as far as I know) today and may not exist until the next century.

APPENDIX D

Designing Allpass Filters (Delay Equalizers) Using FCAD 1.70

Philip Karantzalis

Introduction

While not intended to do so, FilterCAD can be used to design allpass filters for phase equalization and phase shifting applications. FilterCAD, in fact, was used in the design of the LTC1264-7 linear phase filter.

The reader is cautioned that the use of FilterCAD in designing allpass filters is an iterative process which requires patience as well as a thorough knowledge of the required delay characteristics of the filter to be designed. In other words, you must know how much deviation from "flat" group delay your design can tolerate because you can never get absolutely flat group delay.

Using FilterCAD to Design an APF

The FilterCAD software can simulate the delay characteristics of an allpass section when the user enters an equivalent lowpass section into the custom menu twice. This simulates the delay characteristics of an allpass section since a 2nd order allpass section has twice the delay of the equivalent lowpass section.

Since the amplitude response of any allpass section is unity, the amplitude response of the filter should be turned off in FilterCAD so the user can concentrate on optimizing the delay performance.

An Example

Figure D1 shows the normalized custom filter menu for a single 2nd order section lowpass filter with a Q of 2.00. The response plot for this single section LPF is shown in Figure D2. Note that, as described above, the gain response has been turned off, and the graph only shows phase (top) and group delay (bottom).

The next graph, Figure D3, is a composite graph showing the effects of various allpass filters on the lowpass section. Note that each allpass section is simulated by using two entries in the custom table. In this example the f_0 of the allpass section was varied from 0.7 to 1.00 and the Q was varied from 0.52 to 0.55. Note again, that minimization of group delay is a fairly tedious process where the designer is required to do many iterations of the allpass filter section(s). It is recommended that a maximum of two

FilterCAD (C) 1988-1990 Linear Technology Corporation

```

FILTER TYPE:      LOWPASS          Press: ↑ to move cursor UP
FILTER RESPONSE:  CUSTOM           ↓ to move cursor DOWN
                                           → to move cursor RIGHT
                                           ← to move cursor LEFT
                                           ENTER to ACCEPT data
                                           ESC to RETURN to FILTER MENU
                                           I to enter INFINITY for value
                                           N to change NORMALIZATION value
    
```

NORMALIZE TO (Hz): 1.0000

	Fo (Hz)	Q	Fn (Hz)		Fo (Hz)	Q	Fn (Hz)
1	1.0000	2.0000	∞	8	0.0000	0.0000	0.0000
2	0.0000	0.0000	0.0000	9	0.0000	0.0000	0.0000
3	0.0000	0.0000	0.0000	10	0.0000	0.0000	0.0000
4	0.0000	0.0000	0.0000	11	0.0000	0.0000	0.0000
5	0.0000	0.0000	0.0000	12	0.0000	0.0000	0.0000
6	0.0000	0.0000	0.0000	13	0.0000	0.0000	0.0000
7	0.0000	0.0000	0.0000	14	0.0000	0.0000	0.0000

AN56 FD1

Figure D1. FilterCAD Menu for 2nd Order Section, Q = 2.00

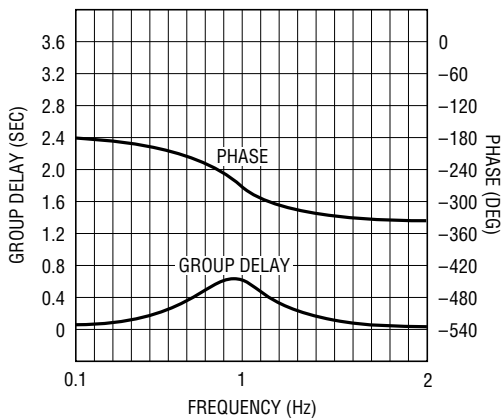

AN56 FD2

Figure D2. Group Delay and Phase Response of Single 2nd Order Section of Figure D1

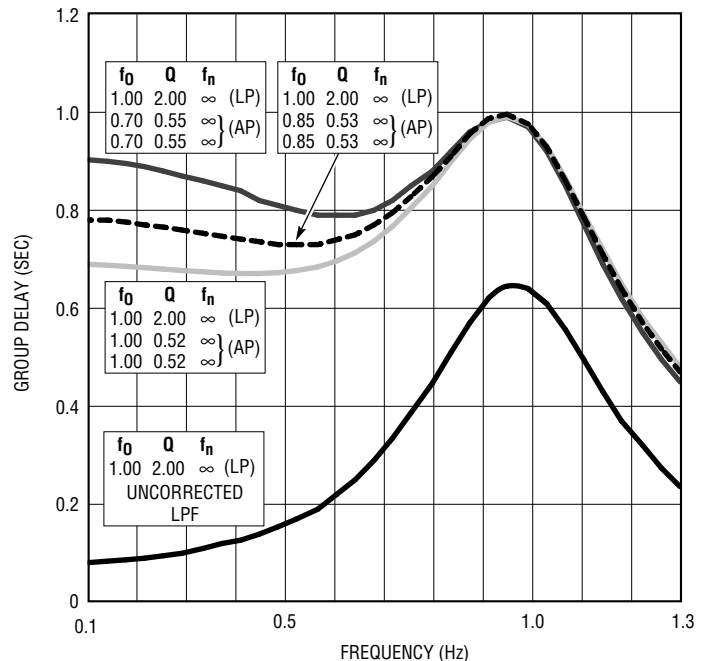

AN56 FD03

Figure D3. Allpass Group Delay Equalization of a Single 2nd Order LPF

allpass sections be used in an equalized filter design. This will avoid compromising the noise performance of the filter system. However, some elliptic filters may require three or four allpass sections for equalization.

The Hardware—Implementation

Any of LTC's universal filters can be used to implement allpass sections as described in this appendix. Remember that implementation *does not* require each section to be entered twice. See Appendix B.

This example shows how a LTC1064-1 elliptic filter can be equalized up to about 90% of its passband using a 6th order allpass designed by iteration and FCAD graphics. By following this example as a starting point, other filters may be equalized using the same (or similar) design procedure.

Application Note 56

FCAD Group Delay Equalization Procedure

1. In lowpass, custom option enter the f_0 and Q values of the filter to be equalized. (Note that f_n values need not be entered.)
2. Below the f_0 and Q values of the lowpass filter enter each allpass f_0 and Q value twice. As explained above, the reason for this is because the delay of an allpass filter is exactly twice that of the equivalent lowpass filter. For this design which uses a 6th order allpass equalizer, three allpass sections must be entered twice.
3. Iterate the values of the f_0 and Q values of the allpass sections only (do not change the values of the lowpass sections) until the desired group delay flatness is obtained. This must be done by alternately viewing the group delay on screen in FCAD and variation of the f_0 and Q values. The procedure is not user friendly or fast, but it can be done and it is certainly faster than the method Bessel used.

The FCAD group delay equalization scheme distorts the gain response plot of the lowpass filter, but this is not a “real” situation since, by definition, the gain response of

an allpass filter is unity. This is the reason that we suggest the gain response of the filter under FCAD be toggled off while equalizing. The reason the gain response of the equalized filter is corrupted is because FCAD thinks the allpass sections entered are lowpass filters and calculates their gain as if they were. Thus, the overall equalized response appears as if the lowpass filter we are interested in equalizing has additional lowpass sections added. To reiterate, the correct gain response of the equalized lowpass filter must be calculated in FCAD by using only the lowpass sections of the filter.

The figures show the precise techniques as implemented in FilterCAD for equalizing an LTC1064-1 elliptic filter with a 6th order allpass section. Figure B1 is the non-equalized group delay of the LTC1064-1. This plot was obtained from FCAD by inputting the 4 stages of the LTC1064-1 lowpass filter into the custom lowpass menu and telling FCAD to plot the group delay response.

Figures B4 and B5 illustrate the theoretical group delay response from the fully equalized filter as plotted in FilterCAD.

APPENDIX E

A Reference Table for Rating Lowpass Filters with Constant Group Delay

Bessel and “Better than Bessel” filters are not the only filters with flat group delay. While these filters do have better characteristics than other filters because they have constant group delay to twice f_c and to f_c , respectively, there is another filter that can be used in some situations. This is the trusty Butterworth filter. While the eye diagram of the Butterworth filter may not look pretty, reasonable results may be obtained by using only part of the passband of the filter when more attenuation is needed (in the stopband) than the Dash 7 type of filter achieves. Table E1 summarizes the Group Delay and attenuation specifications for several filters. The table may be used as a simple selection guide.

Table E1. Flat Group Delay Filter Design Table

FILTER	GROUP DELAY	ATTENUATION (dB)		
		(Filters are Normalized to $f_c = 1$)	At $f_c = 2$	At $f_c = 3$
Dash 7 Better than Bessel	Flat to $f_c = 1$	-36	-69	-77
Dash 3 Bessel	Flat to $f_c = 1.912$	-13.3	-32.7	-51.6
Dash 2 Butterworth	Flat to $f_c = 0.376^*$	-49	-76	-96
	Flat to $f_c = 0.494^{**}$	-49	-76	-96

* Flat group delay to +5%

** Flat group delay to +10%